



24VDC

VIRTUAL  
ENCODERSTC  
SYSTEMarc  
only

KNX



BeUP



64



# BULL424SW

# BULL624SW

## RESIDENTIAL | COMMERCIAL USE

control unit with built-in receiver and virtual encoder  
built-in ESA+ system  
personalised release key

**up to 600 kg**

## 24 Vdc | intensive use

- 24 Vdc Irreversible gear motor for intensive use with built-in control unit equipped with 115/230 Vac switching power supply that allows a low consumption and a longer lifespan of the operator
- Control unit with trimmers and dip-switches
- The virtual encoder enables optimal management of slowing-down phases, movement tracking (STC system) and torque management in relation to the position of the gate, guaranteeing maximum safety
- Operation guaranteed even in the event of a power supply failure through batteries that can be perfectly integrated in the motor (2 x 1.2 Ah)
- Anti-crushing system with amperometric obstacle detection
- Designed for the connection of the X.BE accessory in order to be integrated with KNX domotics installations and the programming through the app BeUP and the interface PRO.UP



## CONTROL UNITS:

**BULL424SW** ——— CP.B24-SW

**BULL624SW** ——— CP.B24-SW



Reinforced foundation plate Dima included.  
Dimensions 326x164.5x2 mm, motor fixing distance 301x75 mm, 4 holes Ø 8.5 mm.

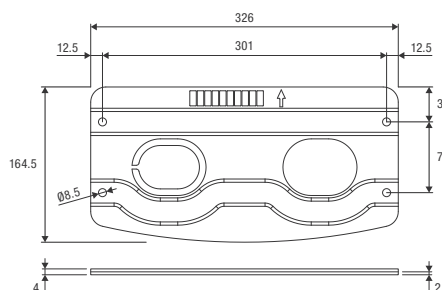
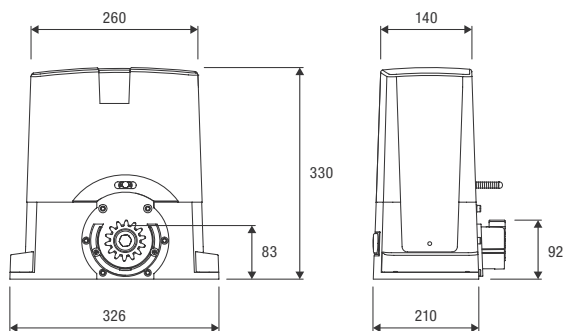

### COMPLETE KITS



MOTOR



PHOTOCELLS



FLASHING LIGHT



TRANSMITTER

**KBULL424SW**1x **BULL424SW**1x **PUPILLA.T**1x **LAMPY**1x **TO.GO2VA****KBULL624SW**1x **BULL624SW**1x **PUPILLA.T**1x **LAMPY**1x **TO.GO2VA**

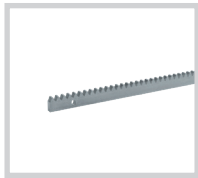

**RI.M4F**

M4 rack, to weld or attach with screws, 30x12x1000 mm slotted and galvanised. Supplied with M6 screws and threaded spacers. **Package of 4 pcs.**

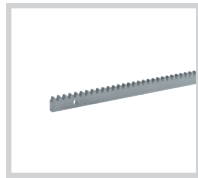

**RI.M4F2**

M4 rack, to weld or attach with screws, 30x12x2000 mm slotted and galvanised. Supplied with M6 screws and threaded spacers. **Package of 1 pc.**

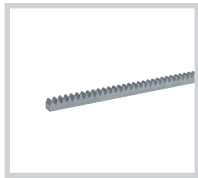

**RI.M4Z**

M4 galvanised rack to weld 22x22x2000 mm. **Package of 1 pc.**

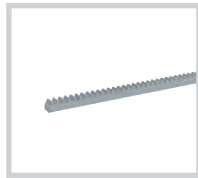

**RI.M4ZF**

Galvanised slotted M4 rack 22x22x2010 mm for fastening to the side with the teeth. Supplied with M6 screws. **Package of 1 pc.**

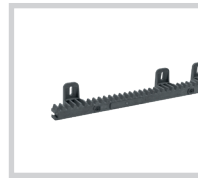

**RI.M4P**

Nylon rack with steel core, to attach with screws, M4, 28x40x1000 mm. Slotted, provided with self-drilling screws. **Package of 10 pcs.**



**BULL.P-1**

Raised foundation plate. Height 34 mm. Floor fixing distance 353x117 mm, no. 4 Ø 11 mm. External dimensions 372x167 mm.



**BULL.P3**

Raised foundation plate. Height 34 mm. Floor fixing distance 260x117 mm, no. 4 Ø 11 mm. External dimensions 326x167 mm.



**SB.BULL8.F**

Externally fitted anti-intrusion cable unlock device (L=4.5m).



**MLS**

Magnetic limit switches. Suitable for snowy places.



**SW.CB**

Accessory equipped with battery charger CB.SW and connection cables.

**AUTOMATISMI BENINCÀ SpA** • Via del Capitello, 45 • 36066 Sandrigo (VI) ITALY • T +39 0444 751030 • sales@beninca.com

TECHNICAL DATA	BULL424SW	BULL624SW
Power supply	115 / 230 Vac (50-60Hz)	115 / 230 Vac (50-60Hz)
Motor supply	24 Vdc	24 Vdc
Max absorbed current	3.2 / 1.7 A	3.2 / 1.7 A
<b>Power consumption in stand-by</b>	<b>0.8 W</b>	<b>0.8 W</b>
Max Thrust	428 N	715 N
Opening speed	5.5 ÷ 11 m/min	5.5 ÷ 11 m/min
Duty cycle	intensive use	intensive use
Protection level	IP44	IP44
Operating temperature	-20°C /+50°C	-20°C /+50°C
Max gate weight	450 kg	600 kg
Driving gear for rack	M4 Z14	M4 Z14
Weight	8.0 kg	8.3 kg
Items no. per pallet	40	40
Kit weight	8.4 kg	8.5 kg
Kits no. per pallet	40	40